



Smartfind S5A
AIS SART
USER MANUAL

THIS DOCUMENT IS COPYRIGHT © 2021 NETWAVE SYSTEMS B.V. AND/OR ITS AFFILIATES. ALL RIGHTS ARE STRICTLY RESERVED. THIS DOCUMENT AND ANY ATTACHED MATERIALS CONTAINS PROPRIETARY INFORMATION AND DATA AND IS THE SOLE PROPERTY OF NETWAVE SYSTEMS B.V. AND/OR ITS AFFILIATES. THE DOCUMENTS, ANY ATTACHED MATERIALS AND/OR INFORMATION CONTAINED THEREIN MUST NOT BE USED, DISSEMINATED, OR DISTRIBUTED EXCEPT FOR THE AGREED PURPOSE. UNAUTHORIZED USE, REPRODUCTION, OR ISSUE TO ANY THIRD PARTY IS NOT PERMITTED WITHOUT THE PRIOR WRITTEN CONSENT OF THE NETWAVE SYSTEMS B.V.

This manual is applicable to the AIS SART type McMurdo Smartfind S5A.

SOS ONLY IN EMERGENCY

During evacuation
Take the AIS SART to help craft localisation during search and rescue operation.



1 - Pull and break the red protection cover
2 - Press & hold ON for 2 seconds: LED flashes orange during GPS fix then green

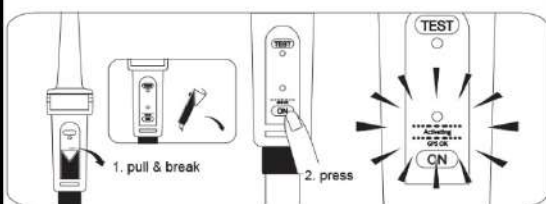

3 - Connect and rotate extension pole into AIS SART
4 - Remove bottom cover and extend pole.

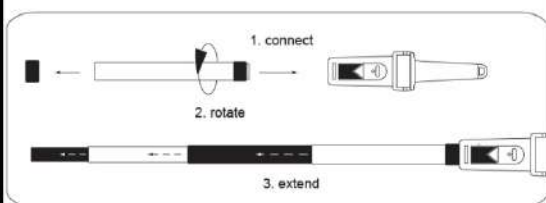

5 - Install pole upright outside the craft or,
Use lanyard to tighten AIS SART to craft.

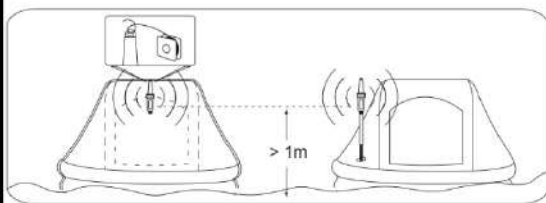

User instructions are also printed directly on the main unit and the deployment instructions are repeated on the inside cover of the carry bag.

CONTENTS

1	SAFETY NOTICES	1
1.1	Use.....	1
1.2	Testing, maintenance and disposal.....	1
1.3	Hazards and Warnings.....	1
1.4	EC Declaration of Conformity.....	2
1.5	FCC Compliance.....	2
1.6	Ownership.....	2
1.7	Disclaimer.....	2
2	OVERVIEW	3
2.1	AIS SART Handling.....	4
2.2	Environmental.....	4
2.3	Controls and indicators.....	4
3	INSTALLATION	5
3.1	Items in the Package.....	5
3.2	Wall bracket installation.....	5
4	EMERGENCY PROCEDURE	7
4.1	Abandon ship!.....	7
4.2	Activation Process.....	8
4.3	Deployment guidelines.....	9
4.4	Mounting outside a canopy life raft.....	10
4.1	Mounting inside a canopy life raft.....	10
4.2	Deactivation Process.....	11
5	AIS SART TARGET VISUALIZATION	12
6	MAINTENANCE	13
6.1	Servicing schedule.....	13
6.2	Self-test & inspection.....	13
6.1	Self-test procedure.....	13
6.2	Mechanical inspection.....	15
	Inspection.....	15
6.3	Anti-tamper Cap replacement.....	15
6.4	Battery replacement.....	15
6.5	Transportation.....	16
6.6	GMDSS inspections.....	16
7	END OF LIFE STATEMENT	17
7.1	Disposal.....	17

8	TECHNICAL SPECIFICATION	18
9	DIMENSIONAL DRAWINGS	19
9.1	AIS SART main unit.....	19
9.2	Pole.....	20
9.3	Bag	21
9.4	Wall mounted bracket.....	22
10	PRODUCT WARRANTY.....	23
10.1	Netwave Systems B.V. Warranty Registration	23
10.2	Warranty Statement.....	23
11	HOW DOES IT WORK?	25

1 SAFETY NOTICES

1.1 Use

An AIS SART 'search and rescue locating device' is designed to assist in survivor craft location during search and rescue operations. AIS SART's are primarily intended for fitment by SOLAS vessels under carriage requirement rules. The rules differ depending on type and size of vessel and life raft. In general, at least one search and rescue locating device is carried on each side of a passenger or cargo ship over 500 gross tons. Smaller SOLAS classified vessels are required to carry at least one search and rescue locating device. An AIS-SART is a portable device and should be stowed on board in a location where it can be easily and rapidly taken on board a survival craft or life raft.

An AIS SART is an emergency radio beacon that is intended for use in maritime emergencies and is approved for these contingencies. It is not designed or recommended for use on land or in the air.

The intended usage of the AIS SART is to mark the location of maritime survivors in need of imminent recovery by rescuers. False alerts endanger lives and cause disruption to Search and Rescue services, deliberate misuse of the AIS SART could result in penalty.

Read the complete manual before installing, testing or using the AIS SART.

1.2 Testing, maintenance and disposal

Self-test the AIS SART every 6 months, more frequent self-testing is not recommended as it can cause unnecessary draining of the battery.

The AIS SART contains no user serviceable parts but a physical check should be performed regularly. The battery pack is a Primary lithium battery. Do not incinerate, puncture, deform or short-circuit. If you need to dispose of battery or the complete AIS SART – see Section 7.

1.3 Hazards and Warnings



ELECTRICAL SHOCK HAZARD.

Do not dismantle the AIS SART, it contains no user-serviceable parts.

The AIS SART contains lithium metal batteries. Do not incinerate, puncture, deform, short circuit or recharge.

Avoid using chemical solvents to clean the AIS SART as some solvents can damage the case material.

The AIS SART is compliant with SOLAS regulations when the anti-tamper cap is intact. After the anti-tamper cap has been broken for any reason, it must be assumed that the SART has been used and the AIS SART the subject of a battery replacement service before being returned to use.

As the AIS SART contains a radio transmitter, some administrations may require that the user holds a maritime radio license authorizing ownership and use.

When activated, the AIS SART emits low levels of radio frequency radiation. It is advisable not to handle the upper section antenna zone.

When the AIS SART has reached its end of its useful in-service life it must be disposed of in accordance with local waste disposal regulations. Refer to End of Life Statement.

1.4 EC Declaration of Conformity

The AIS SART is in compliance with the essential requirements and other relevant provisions of the Marine Equipment Directive (MED). A copy of the Declaration of Conformity can be obtained online from:

<https://www.seasofsolutions.com/support/mcmurdo/marine-products>

1.5 FCC Compliance

The AIS SART is in compliance with the GMDSS provisions of Part 80 of the FCC rules.

1.6 Ownership

It is not required for the AIS SART owner to file a product registration with the maritime authority's. It is recommended that a record of the AIS SARTs' identifier number is included in this user manual (complete box below) and filed for safe keeping with the vessels own management organization. The AIS SART is marked with a 9-digit manufacturer serialized TX ID (MMSI) number printed on the main body label for this purpose.

Ownership details										
Vessel Name:										
Owner details:										
TX ID ;	<table border="1"><tr><td>9</td><td>7</td><td>0</td><td>1</td><td>7</td><td></td><td></td><td></td><td></td></tr></table>	9	7	0	1	7				
9	7	0	1	7						

1.7 Disclaimer

The manufacturer reserves the right to change this specification at any time without notice and hereby specifically disclaims liability for any consequences of such action.

2 OVERVIEW

Only remove the RED anti-tamper Cap if you intend to operate the AIS SART in a real emergency. An AIS SART is a single use device, once activated and before returning it to storage a maintenance service battery replacement will be required.



Figure 1: AIS SART key features description

2.1 AIS SART Handing

The AIS SART is packed inside a buoyant carry bag with carry strap. The carry bag contains the AIS SART main unit, a 1-meter telescopic extension pole and 10 meters buoyant lanyard. The carry bag may be wall mounted using the wall-mount bracket provided.



Figure 2 Carry bag overview

2.2 Environmental

The carry bag offers additional protection to the AIS SART both for storage and when carrying on to a survival craft. Once assembled and ready for deployment the main unit remains buoyant, waterproof and is tested to survive a 20m drop in to water without damage.

2.3 Controls and indicators

The control panel has florescent backlighting that increases its visibility in reduced lighting conditions. The ON button is protected from accidental activation under a single use anti-tamper cap. Once activated a dual color Red/Orange LED indicator provides real-time status induction and will flash the Morse Code “SOS” sequence.

3 INSTALLATION

3.1 Items in the Package

The AIS SART is typically delivered with standard package as listed in Table 1 and illustrated in Figure 3.

Table 1 Standard equipment list

Item N°	Designation	Quantity
1	AIS SART	1
2	Carry bag	1
3	1 m extension Pole	1
4	Wall mounted bracket	1
5	10 m buoyant lanyard	1
6	Screw M4x20	2
-	User manual (not shown)	1

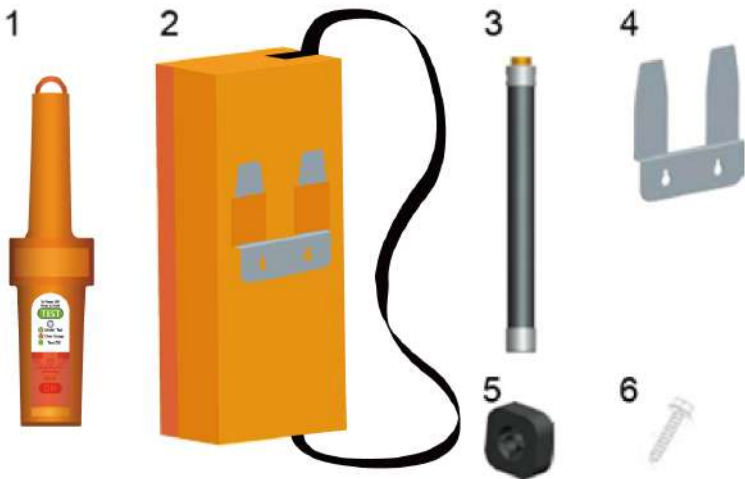

Figure 3 Standard Package

3.2 Wall bracket installation

When selecting a suitable mounting position consider the following points:

1. Ease of access in an emergency, adjacent to the ship's bridge wing exits ready for easy access is recommended.
2. Position at least 1m from compass equipment.

3. Environmental protection, chose a protected location away from the extreme effects of the weather and protected from powerful vessel wash down hoses.
4. Allow clearance above so that the AIS SART can be easily removed from the bulkhead bracket.

Mounting procedure

Fix the mounting bracket to the ships wall using marine grade stainless steel screws or bolts; length is dependent upon application. Bolts should be secured with either stainless steel locking nuts or stainless-steel nuts with stainless steel shake proof washers.

The wall bracket is designed to mount on a flat surface using two fixing points. Two stainless steel screws 20mm in length are included. Check that the rear side of the mounting surface is clear and that the fixing screws will not penetrate something they should not. Offer the bracket into the chosen position and mark through the mounting slots using the bracket as a template.

Drop the AIS SART carry bag rear pockets over the bracket hook section and push the bag firmly into place.

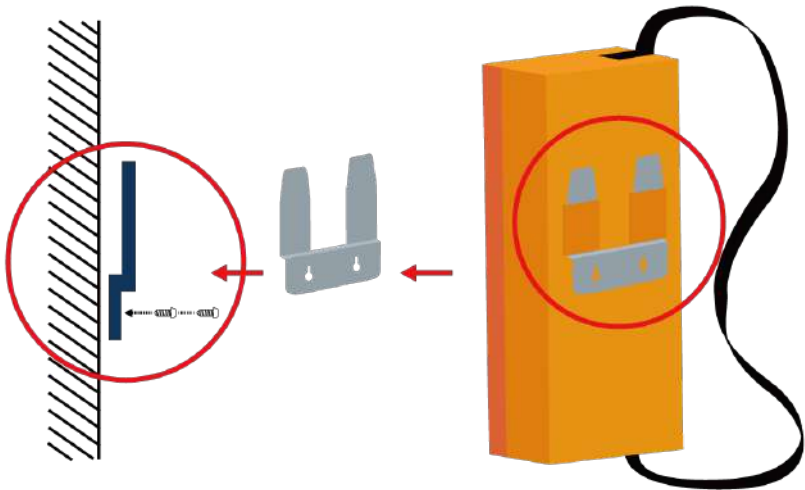

Figure 4 Wall mounting bracket

4 EMERGENCY PROCEDURE

An AIS SART is a piece of life saving equipment. Its sole purpose is to help survivor location during SAR operations. It must only be used in situations of imminent danger.

4.1 Abandon ship!

Step 1:

Lift Carry Bag off the wall bracket.

Step 2:

Take Carry Bag into the Life Boat.

Step 3:

Open Carry Bag and take AIS SART, Extension Pole and buoyant lanyard out

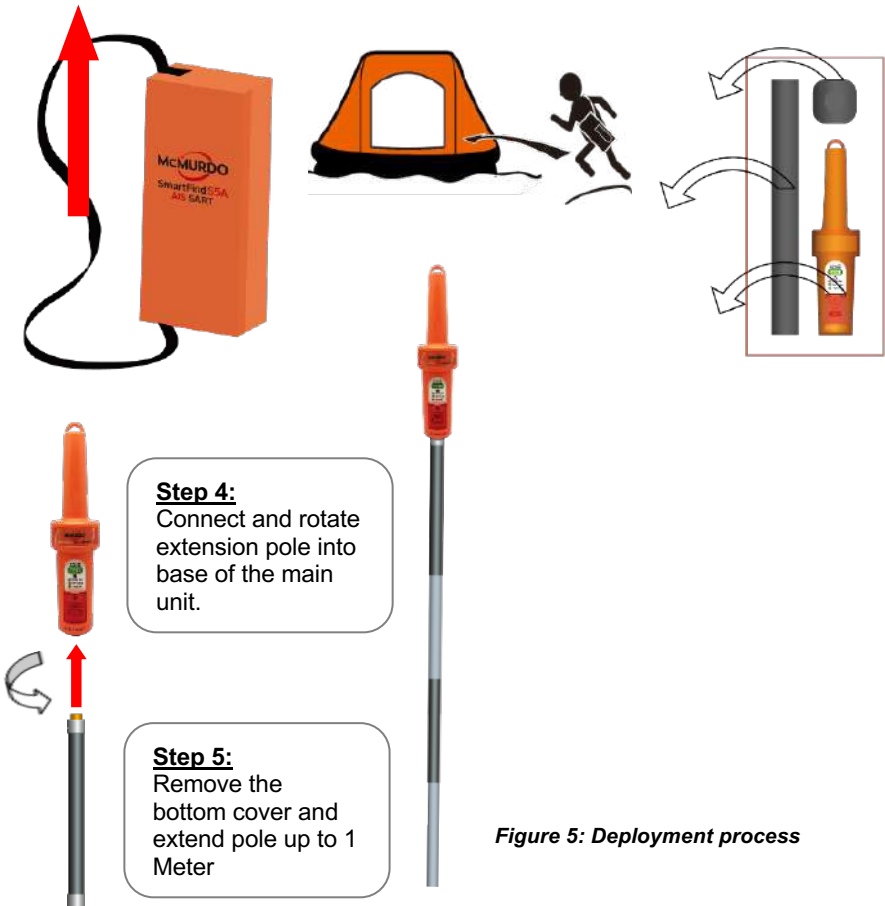
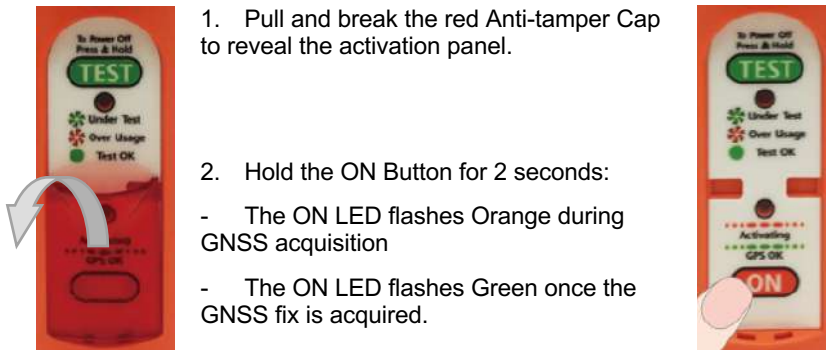

Figure 5: Deployment process

4.2 Activation Process



WARNING: DO NOT COVER GNSS AREA WHILE ACTIVE (see Figure 6)



Figure 6: GPS/GNSS AREA Location

NOTE 1: The GNSS receiver is activated (cold start) when ON is depressed and the Orange LED indicator will initially flash changing to a Green LED indication when a position fix has been resolved.

NOTE 2: The ON LED flashing sequence is the SOS Morse code flashed every 30 seconds.

NOTE 3: The red Anti-tamper Cap breaks once pulled out and cannot be re-installed by the user.

4.3 Deployment guidelines

The AIS SART will work best when the top section has an unobstructed view of the sky. If it is not possible to pick a location with a totally unobstructed view of the sky, do your best to maximize the sky view. The antenna datum marked on the pole section should be positioned more than one meter above sea level when the AIS SART is deployed.

Tie the securing lanyard to the survival craft to avoid loss of the AIS SART, activate and deploy the AIS SART.

Method 1

Step 1:

Release buoyant lanyard secured to top of the AIS SART



Step 2:

Hang the AIS SART inside the life raft at a height of at least 1 meter above water level

Method 2

Step 1:

Extend the pole up to 1 meter.

Step 2:

Pass the pole through the life raft canopy port hole and secure the pole in vertical position..

Tip:

Tie the lanyard cord between the AIS SART and the survival craft to prevent its loss.



Figure 7: deployment

4.4 Mounting outside a canopy life raft

1. Fully extend the telescopic mounting pole:

Remove the rubber cover from the bottom of the mounting pole; allow the pole sections to drop. Lock each section together by twisting each section.

2. Release the lanyard spool and tether the free end of the lanyard to a securer fixing point within the survival craft.
3. Insert the AIS SART through the SART deployment port in the survival craft canopy. Position the bottom of the support pole within the locating pocket. Secure the pole to the canopy support.

Depending on the type of survival craft, the mounting pole can also be located on the outboard side of the survival craft at the doorway entrance on the boarding ramp side. The AIS SART is mounted in the same way except the pole is secured to the buoyancy support.

4.1 Mounting inside a canopy life raft

The SART should be switched ON and suspended at highest point of the survival craft; by its top loop using the lanyard provided.

Note: Operating the AIS SART inside a closed Survival Craft or under a canopy may reduce its performance.

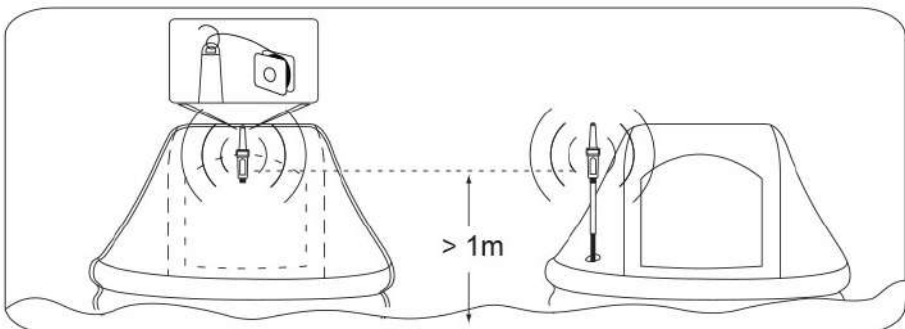

Figure 8: deployment options

4.2 Deactivation Process



1. Hold the TEST button for over 3 seconds to initiate power off.
2. Keep holding TEST until the ON LED stops flashing:
The AIS SART is then deactivated.

Figure 9: Deactivation

NOTE: After de-activating, all LEDs shall be off. If any LED is still flashing, press the TEST button again for more than 3 seconds to de-activate the unit.

5 AIS SART TARGET VISUALIZATION

Under active or test mode, the AIS SART will transmit a message with a 9 digit TX ID number (MMSI) identity in the following format; 97016YYYY

The AIS SARTs GNSS derived position in latitude and longitude and the TX ID will be display on the vessels navigation display or AIS receiver equipment.

A SELF TEST mode generated message is displayed as “SART TEST”

The live emergency transmission is displayed as “SART ACTIVE”

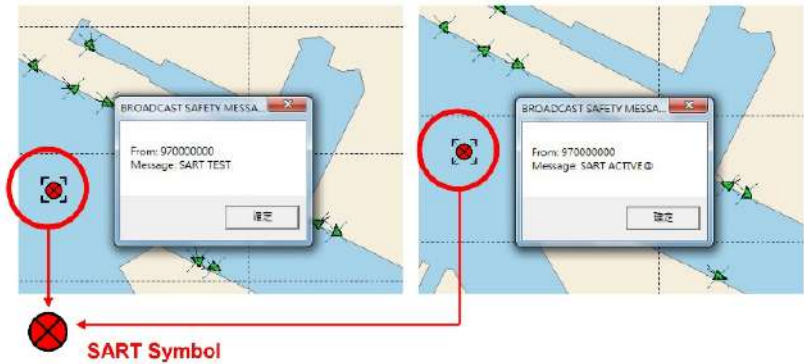

Figure 10: AIS SART Target Visualization

6 MAINTENANCE

6.1 Servicing schedule

As an important item of safety equipment, your AIS SART should be checked regularly according to the following schedule:

Service Interval		
1 month	6 months	6 years
Physical check	Physical check and Self-test	Dealer Battery replacement

All servicing should be carried out by an Approved Service Agent. Always call your nearest Approved Service Agent and talk to their customer service department before returning equipment. You can find your nearest Approved Service Agent from:

- The Netwave Systems website: <http://www.seasofsolutions.com/>
- Contacting Netwave Systems direct
- Contacting a distributor of Netwave products

If the AIS SART must be returned, the original packaging should be used if possible.

Check your AIS SART for any damage or wear and tear according to the manufacturer's instructions (please refer to <http://www.seasofsolutions.com/> for further details).

6.2 Self-test & inspection

It is recommended to self-test the AIS SART every 6 months; more frequent self-testing can put unnecessary drain on the battery. When self-testing, a specially coded AIS test transmission is sent that will be visible to all AIS users in the locality. As a successful self-test result is dependent on GNSS position acquisition; testing must be carried out in the open and under an unobstructed sky.

6.1 Self-test procedure

Remove the AIS SART from its carry bag and assemble the top section onto the mounting pole. It is not necessary to fully extend the mounting pole. Take the AIS SART outside and hold it aloft under a clear view of the sky; this will then maximize the speed of the GNSS position fix.

1. Hold "TEST" button for over 3 seconds

WARNING:DO NOT COVER GPS AREA WHILE ACTIVE (see Figure 6)
--

2. The indicator will flash Green LED or Orange LED .

NOTE 1 – Normally the green flashing will happen in 2 mins right after the GPS/GNSS position is fixed. If it happens at the 5th minute, the SART message will be transmitted automatically, and GPS/GNSS position might not be fixed. Please move the AIS SART to a new location which has a clear view of the sky.

NOTE 2 – Orange flashing means the AIS SART has been previously activated or self-tested more than the maximum of 100 times.



Figure 11: Testing of AIS SART

Indicator	Meaning
Green	AIS SART is under testing without over usage warning
Orange	AIS SART is in under testing with over usage warning
1 long Green	AIS SART complete transmission and light-off after long green color flash automatically.

NOTE 1 – “Over usage” is caused by the following three situations: battery is run down, unit has been tested over 100 times, unit has been activated before.

NOTE 2 – If the green or orange color is flashing over 3 minutes, GPS/GNSS position may not be acquired. Move the AIS SART to a different location with a clear view of the sky overhead.

6.2 Mechanical inspection

Inspection

It is recommended to physically check AIS SART routinely to verify:

- The battery expiry date has not been exceeded.
- Evidence of any damage to the main body, Wall mounted bracket, Carry bag, Extension Pole, Buoyant Lanyard.
- Evidence of dirt; to clean AIS SART only using fresh water then wipe dry.

WARNING – Do not use any chemical liquid on AIS SART or its accessories.

6.3 Anti-tamper Cap replacement

The AIS SART has a Red anti-tamper protection cap that will be broken during activation. An AIS SART is a single use device, once activated and before returning it to storage a maintenance service battery replacement will be required.

NOTE – To replace the anti-tamper cap and battery, please contact your local approved service agent.

6.4 Battery replacement

The battery pack should be replaced every 6 years or when it reaches its expiry date or if the AIS SART has been activated.

The battery pack expiry date is marked on the AIS SART main body label. The battery expiry date should be checked regularly.

Lithium batteries have special disposal requirements. Never incinerate a lithium battery. Never dispose of one at sea. Your approved service agent will be able to deal with battery disposal.

NOTE – It is recommended that battery change should be performed by an authorized service agent in order that a complete assessment and integrity check can be performed. To replace a battery pack, please contact your local approved service agent.

6.5 Transportation

This information is given in good faith and is believed to be accurate at the date of preparation. Netwave Systems B.V. makes no warranty, either express or implied, with respect to this information, and disclaims all liability from reference on it.

Transport Information

Class: Class 9
UN Number: UN3091
UN Description: Lithium Metal Batteries Contained in Equipment
IATA Packing Instruction for Air: 970 Section II
Packing Instruction for Road & Sea: P903 Special Provision 188

For further information, please refer to the Seas of Solutions website:
<https://www.seasofsolutions.com/support>.

6.6 GMDSS inspections

Vessel that are subject to GMDSS regulations can expect regular visits from ship surveyors enforcing national legislation. They might check the expiry dates and test the AIS SART to prove that it is operational.

Leisure vessels are not subject to these inspections. However, in some countries, passenger and fishing vessels are also subject to inspection.

7 END OF LIFE STATEMENT

At the end of the product's useful life, it is vital that the battery pack be disconnected from the main unit to prevent false alarms. False alarms cause expensive disruption to Search and Rescue services and may endanger lives as a consequence.

This operation should only be performed by qualified service personnel.

This product should be disposed of in a sensible and considerate manner and in accordance with local regulations. Take it to a civil recycling facility or contact Netwave for advice.

7.1 Disposal

The Waste Electrical and Electronic Equipment (WEEE) Directive aims to minimize any adverse impact of electronic equipment on the environment, both during the product lifetime and when it becomes waste. Within the European Union this legislation is mandated by Directive 2012/19/EU, and there is similar legislation in most other continents. The directive applies to all electronic products such as IT, household appliances, portable electronics etc., and imposes requirements to collect, treat, recover and recycle each product at its end of life. Electronic end-user products must also carry a WEEE label (as below) and recovery and recycling information has to be provided to the recycler.



This AIS SART product contains traces of lithium in the battery pack. In keeping with the directive, Netwave strongly recommends that this AIS SART product and its battery pack be disposed of in a sensible and considerate manner. For example, do not simply discard the product in the domestic waste. Instead take it to a civil recycling facility or contact Netwave for advice.

Green Passport: Ship Recycling Information

Netwave Systems B.V. hereby declares potentially hazardous content in some of its electronic products.

Small amounts of the following substances may be present: beryllium oxide, lithium, lead (in older products), brominated flame retardants, glass.

In keeping with the provisions of IMO Resolution A.962(23) (Guidelines On Ship Recycling), Netwave strongly recommends that its products, including any battery packs, be disposed of in a considerate and legal manner.

8 TECHNICAL SPECIFICATION

VHF transmitter	Operating Frequencies	AIS1, 161.975 MHz AIS2, 162.025 MHz
	Data Rate	9,600 bps
	Bandwidth	25 kHz
	Power output	1 W EIRP
	AIS Message Type	Message 1, Message 14
	Modulation	GMSK
	Antenna	Integrated by PCB
GPS receiver	Satellites tracked	48 channels
	Acquisition Sensitivity	-159 dBm
	Tracking Sensitivity	-159 dBm
	Position Accuracy	< 2.5 m Autonomous & SBAS
Battery	Type	Primary Lithium (not rechargeable)
	Operating life	96 hours minimum
	Storage	6 years
	Service	Replacement by authorized agent
Environment	Operating temperature	-20 °C to +55 °C (-4° F to +131° F)
	Storage temperature	-30 °C to +70 °C (-22° F to +158° F)
	Waterproof	Immersion to 10 m
	Buoyancy	Floats
	Exterior Finish	Highly Visible Yellow
	Compass Safe Distance	Standard Magnetic – 0.60 m Steering Magnetic – 0.40 m
Dimensions (AIS SART)	Weight	283 g (Battery included)
	Max Diameter	70 mm
	Length	300 mm
Dimensions (Pole)	Weight	300 g
	Length	1050 mm extended
Dimensions (Storage Package)	Weight	1080 g
Carry & Mounting	Means of carrying	Carry Bag
	Means of mounting	Wall Mount bracket
Standards	International standards	IEC 61097-14 Ed.1 (2010) IEC 60945 Ed. 4 (2002) incl. Corrigendum 1 (2008)
	ITU regulations	ITU-R M.1371-5 (2014)
	IMO resolutions	IMO Resolution MSC.246 (83)

9 DIMENSIONAL DRAWINGS

NOTE: All dimensions are in millimeters

9.1 AIS SART main unit

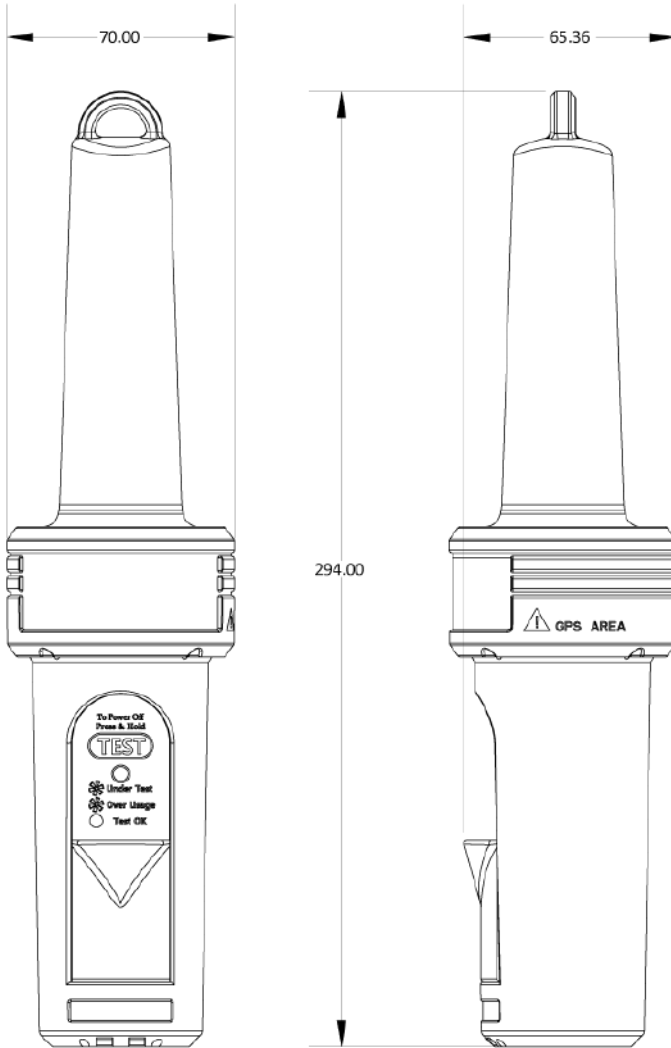

9.2 Pole

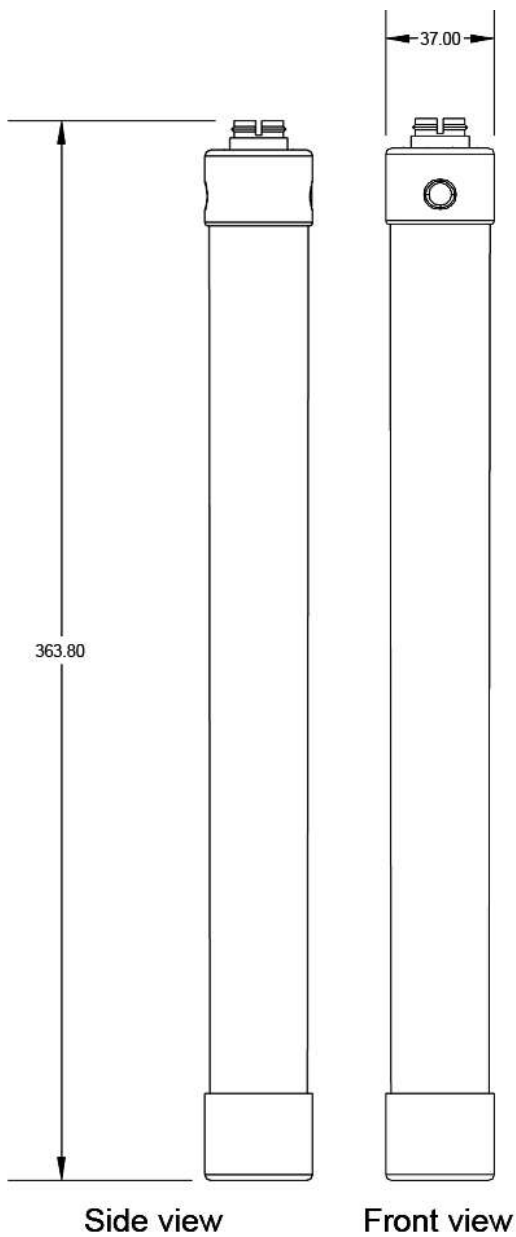

9.3 Bag

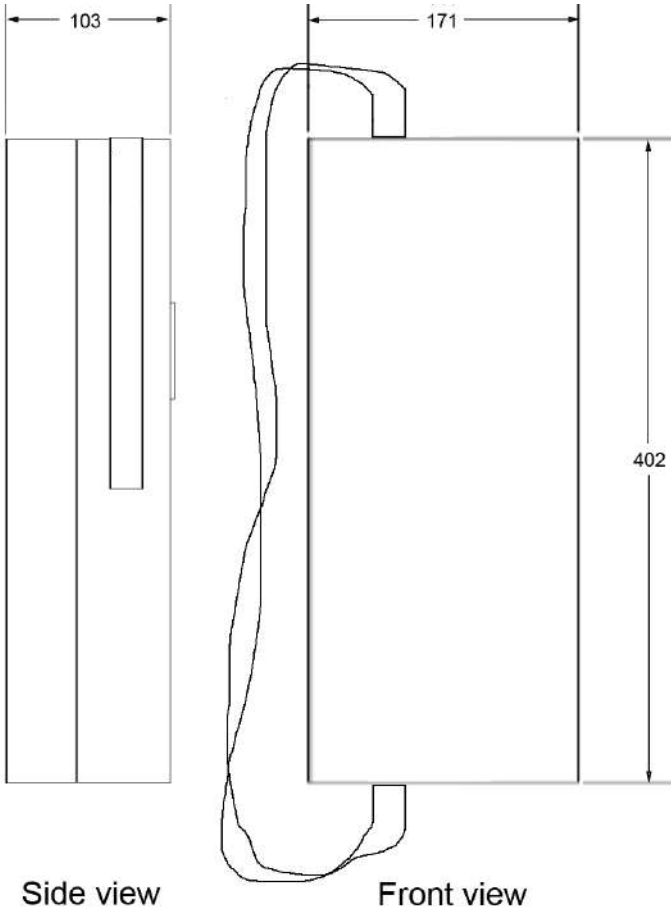

9.4 Wall mounted bracket

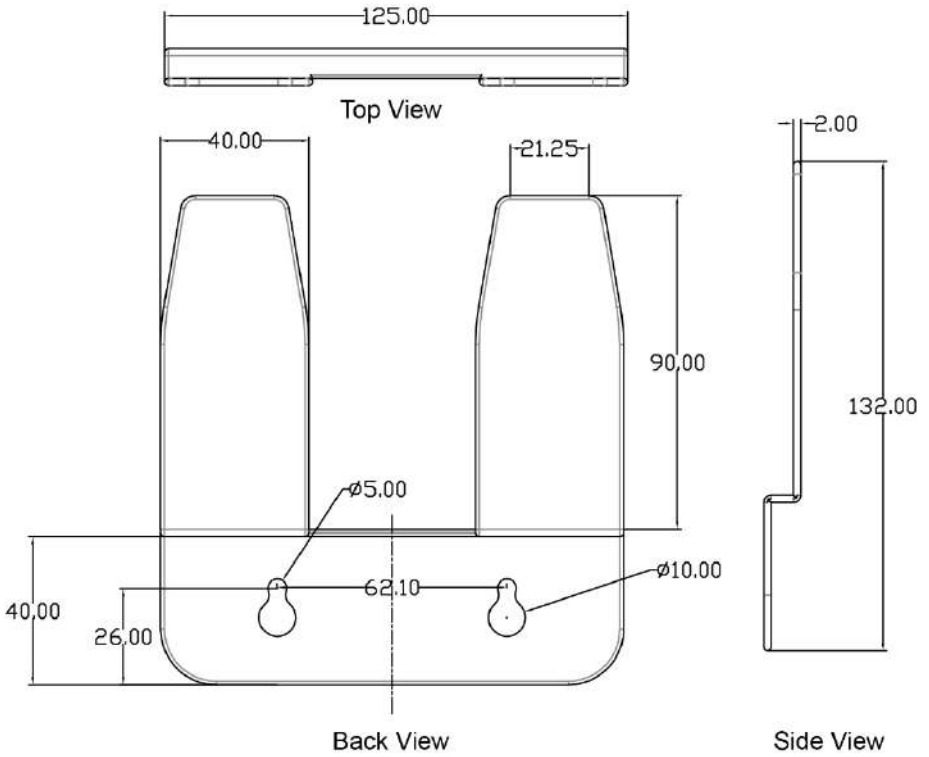

10 PRODUCT WARRANTY

10.1 Netwave Systems B.V. Warranty Registration

Congratulations on purchasing your AIS SART. As standard, your unit has a one year (12 months) warranty from the date of purchase shown on your invoice, however, this can be extended by a further 1 year by simply registering your unit on-line within 90 days of purchase at:

<http://www.seasofsolutions.com/> then follow the REGISTER WARRANTY link at the top of the page.

10.2 Warranty Statement

Subject to the provisions set out below Netwave Systems B.V. warrants that this product will be free of defects in materials and workmanship for a period of up to two years (see above) from the date of purchase. Netwave Systems B.V. will not be liable to the buyer under the above warranty:

- For any defect arising from fair wear and tear, wilful damage, negligence, abnormal working conditions, failure to follow McMurdo's instructions (whether oral or in writing) including a failure to install properly and/or to use batteries recommended and/or supplied by McMurdo, misuse or alterations or repair of the product by persons other than Netwave Systems B.V. or an Approved Service Agent.
- For parts, materials or equipment not manufactured by Netwave Systems B.V. in respect of which the buyer shall only be entitled to the benefit of any warranty or guarantee given by the manufacturer to Netwave Systems B.V.;
- For the battery storage life which is specifically excluded from this warranty;
- If the total price for the product has not been paid.

THE LIMITED WARRANTY STATED ABOVE IS EXCLUSIVE AND IN LIEU OF ANY OTHER WARRANTY, EXPRESS OR IMPLIED, INCLUDING BUT NOT LIMITED TO ANY IMPLIED WARRANTY OF MERCHANTABILITY OR FITNESS FOR A PARTICULAR PURPOSE.

Netwave Systems B.V. will not be liable for indirect, special, incidental or consequential damages of any kind sustained from any cause. In no event shall Netwave Systems B.V. be liable for any breach of warranty or other claim in an amount exceeding the purchase price of the product. This warranty does not affect any statutory rights of the consumer. In order to be valid, claims must be made under the above warranty in writing as soon as practicable after discovery of the defect or failure and within the warranty period referred to above. Proof of purchase will be required. The claim should be sent together with the product in question to the address set out below or to an Approved Service Agent. Following a valid warranty claim Netwave Systems B.V. shall be entitled to repair or replace the product (or part) in question free of charge,

or at Netwave Systems B.V.'s sole discretion to refund to the buyer the price of the product (or a proportional part of the price). Netwave Systems B.V. shall not be liable to a buyer who is not a consumer for any other loss or damage (whether indirect, special or consequential loss of profit or otherwise) costs, expenses or other claims for compensation which arise out of or in connection with this product.

Nothing shall limit Netwave Systems B.V.'s liability for death or personal injury caused by its negligence. This warranty is to be interpreted under Dutch law.

All enquiries relating to this warranty or Approved Service Agents should be sent to:

Netwave Systems B.V.
Blauw-roodlaan 100,
2718 SJ Zoetermeer, Netherlands
Phone: +31 (0) 8811 81500

Telephone: +31 (0) 8811 81500

Web: <http://www.seasofsolutions.com/>

Email: customer.service@seasofsolutions.com

11 HOW DOES IT WORK?

The AIS SART is a Search And Rescue Transponder/Transmitter, designed for survivor location during search and rescue operations. From 1st of January 2010, AIS SART was adopted into the GMDSS (Global Maritime Distress Safety System, Figure 10) regulations as an alternative to the traditional SART equipment, RADAR SART.

AIS SART provides a greater level of identification and a GNSS based position during search and rescue operation period than can be provided by a RADAR SART. The AIS SART transmitting frequency (161.975MHz & 162.025MHz) is fully interoperable with the other uses of the maritime AIS system. AIS SART combines two antennas, GNSS (GPS) and VHF, and transmits the latitude and longitude, message 1 and message 14 to other AIS station.

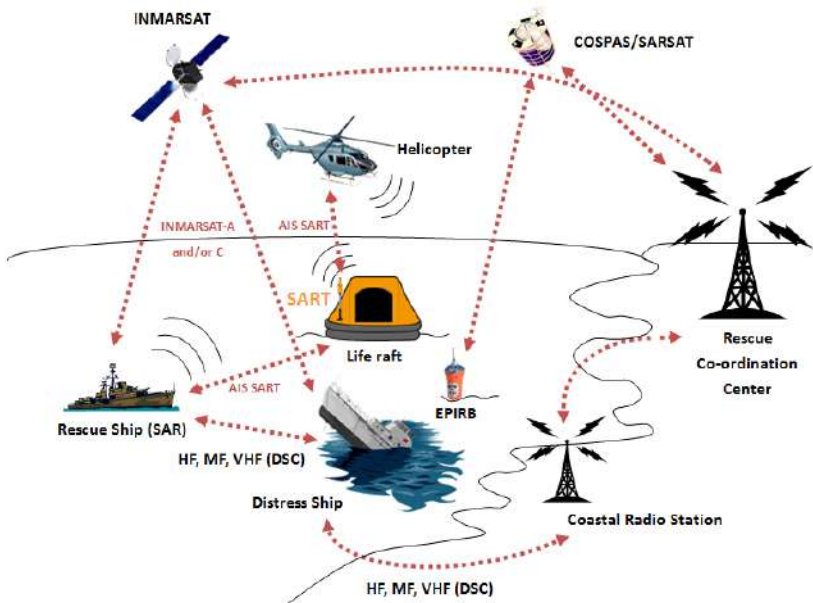

Figure 12 SART in Global Maritime Distress Safety System (GMDSS)

NOTE:

NOTE:

Netwave Syatems B.V.

Blauw-roodlaan 100,
2718 SJ Zoetermeer,
Netherlands

Phone: +31 (0)8811 81500

Email: customer.service@seasofsolutions.com

Website: www.seasofsolutions.com/

21-135-001N Issue 16

A Seas Of Solutions Business