



**R5 GMDSS VHF
Handheld Radio
USER MANUAL**

Emergency procedure

- Remove the top-seal of the yellow emergency battery package.
- Insert the battery package into the handheld transceiver.
- Turn the knob at the top of the radio clockwise. The display lights up showing the last used channel and the battery level.
- Select channel 16 (Distress or Safety), press the **16/C key**.
- Press the PTT and say:
 - “MAYDAY, MAYDAY, MAYDAY”,
 - “This is”..... ships name repeated three times
 -
 - “MAYDAY”
 - “This is”..... ships name and call sign,
 - The ship’s position in latitude and longitude or other reference to a known geographical location,
 - The nature of distress and assistance wanted,
 - Any other information which might facilitate the rescue.
 - “OVER”
- Release PTT and listen for answer.

Warranty limitation

IMPORTANT - The radio is a sealed waterproof unit. To create and maintain its waterproof integrity it was assembled in a controlled environment using special equipment. The radio is not a user maintainable unit, and under no circumstances should the unit be opened except by authorized personnel. Unauthorized opening of the unit will invalidate the warranty.

Disclaimer

The information and illustrations contained in this publication are to the best of our knowledge correct at the time of going to print. We reserve the right to change specifications, equipment, installation and maintenance instructions without notice as part of our policy of continuous product development and improvement. No part of this publication may be reproduced, stored in a retrieval system or transmitted in any form, electronic or otherwise without permission in writing from Orolia Ltd. No liability can be accepted for any inaccuracies or omissions in the publication, although every care has been taken to make it as complete and accurate as possible. This manual is applicable for McMurdo R5 GMDSS VHF handheld radios manufactured after June 2017.

WARRANTY STATEMENT

EN

IMPORTANT

Orolia Ltd warranty registration

Congratulations on purchase. As standard your unit has a one year (12 months) warranty from the date of purchase shown on your invoice, However, this can be extended by simply registering your unit online at:

www.mcmurdogroup.com

Then follow the REGISTER WARRANTY link at the top of the page.

Warranty Statement

Subject to the provisions set out below Orolia Ltd warrants that this product will be free of defects in materials and workmanship for a period of 12 months from date of purchase and up to 24 months from the date of purchase upon registration of the radio as stated above. Orolia Ltd will not be liable to the buyer under the above warranty:-

for any defect arising from fair wear and tear, wilful damage, negligence, abnormal working conditions, failure to follow Orolia Ltd's instructions (whether oral or in writing) including a failure to install properly and/or to use batteries recommended and/or supplied by Orolia Ltd, misuse or alterations or repair of the product by persons other than Orolia Ltd or an Approved Service Agent;

for use of parts, materials or equipment not recommended by Orolia Ltd in respect of which the buyer shall only be entitled to the benefit of any warranty or guarantee given by the manufacturer to Orolia Ltd;

for the battery which is specifically excluded from this warranty;

if the total price for the product has not been paid.

THE LIMITED WARRANTY STATED ABOVE IS EXCLUSIVE AND IN LIEU OF ANY OTHER WARRANTY, EXPRESS OR IMPLIED, INCLUDING BUT NOT LIMITED TO ANY IMPLIED WARRANTY OF MERCHANTABILITY OR FITNESS FOR A PARTICULAR PURPOSE. Orolia Ltd will not be liable for indirect, special, incidental or consequential damages of any kind sustained from any cause. In no event shall Orolia Ltd be liable for any breach of warranty or other claim in an amount exceeding the purchase price of the product. This warranty does not affect any statutory rights of the consumer.

In order to be valid, claims must be made under the above warranty in writing as soon as practicable after discovery of the defect or failure and within the warranty period referred to above. Proof of purchase will be required. The claim should be sent together with the product in question to the address set out below or to an Approved Service Agent.

Following a valid warranty claim Orolia Ltd shall be entitled to repair or replace the product (or part) in question free of charge, or at Orolia Ltd's sole discretion to refund to the buyer the price of the product (or a proportional part of the price). Orolia Ltd shall not be liable to a buyer who is not a consumer for any other loss or damage (whether indirect, special or consequential loss of profit or otherwise) costs, expenses or other claims for compensation which arise out of or in connection with this product. In the case of a consumer Orolia Ltd shall only be liable where other loss or damage is foreseeable.

Nothing shall limit Orolia Ltd's liability for death or personal injury caused by its negligence. This warranty is to be interpreted under English law.

All enquiries relating to this warranty or Approved Service Agents should be sent to:

Orolia Ltd, Silver Point, Airport Service Road, Portsmouth, Hampshire, PO3 5PB, UK
Telephone: Int + 44 (0) 23 9262 3900 Fax: Int + 44 (0) 23 9262 3998

Email:
customer.service@mcmurdogroup.com

A Company of the Orolia Group

END OF LIFE STATEMENT

Disposal

The Waste Electrical and Electronic Equipment (WEEE) Directive aims to minimise any adverse impact of electronic equipment on the environment, both during the product lifetime and when it becomes waste. Within the European Union this legislation is mandated by Directive 2012/19/EU, and there is similar legislation in most other continents. The directive applies to all electronic products such as IT, household appliances, portable electronics etc., and imposes requirements to collect, treat, recover and recycle each product at its end of life. Electronic end-user products must also carry a WEEE label (as below) and recovery and recycling information has to be provided to the recycler.



This product contains traces of lithium in the battery pack. In addition it may contain lead and brominated flame retardants (BFRs), both in the housing material and circuit boards. In keeping with the directive, Orolia Ltd strongly recommends that this product and its battery pack be disposed of in a sensible and considerate manner. For example, do not simply discard the product in the domestic waste. Instead take it to a civil recycling facility, or contact Orolia Ltd for advice.

This device complies with the GMDSS provisions of part 80 of the FCC rules.

EC Declaration of Conformity

Hereby Orolia Ltd declares that this product is in compliance with the essential requirements and other relevant provisions of the Marine Equipment Directive (MED) – 2014/90/EU. A copy of the Declaration Of Conformity can be obtained on line from;

www.mcmurdogroup.com

Precautions

Avoid water and salt in the I/O connector and keep it clean frequently.

Only use original battery packs. Make sure they are clean and dry before attaching the transceiver. Be careful not to damage any gaskets.

Only use the original charger for the rechargeable battery.

Be very careful when handling the Lithium batteries. With correct use they are safe but any misuse might cause dangerous situations.

Never short circuit the battery terminals, never expose the transceiver and the batteries to extreme temperature or fire and never use any kind of violence.

Avoid close contact between the antenna and parts of the human body. The top of the antenna must never be closer than 5 cm to the body when transmitting.

Do not submerge the transceiver more than 1 m for 30 minutes.

Keep the transceiver at least 0.3 m away from the magnetic compass.

Training information

McMurdo R5 GMDSS VHF is designed for "occupational use only". It must be operated by licensed personnel only.

The R5 complies with the FCC RF exposure limits for "Occupational Use Only".

- FCC OET Bulletin 65 Supplement C, evaluating compliance with FCC guidelines for human exposure to radio frequency electromagnetic fields.
- American National Standards Institute (C95.1) IEEE standard for safety levels with respect to human exposure to radio frequency electromagnetic fields, 3 kHz to 300 GHz.
- American National Standards Institute (C95.3) IEEE recommended practice for the measurement of potentially hazardous electromagnetic fields - RF and microwaves.



Warning! Your VHF radio generates electromagnetic RF (radio frequency) energy when transmitting. To ensure that you are not exposed to excessive amounts of energy and thus to avoid health hazards from excessive exposure to RF energy, all persons must be at least 5 cm away from the antenna when the radio is transmitting.

Correct use

For best performance, hold the radio vertically and 10 cm away from the head when talking into the microphone.

Contents

Chapter 1 Introduction

Your GMDSS VHF	1
Performance	2
Channels	2

Chapter 2 Operation

Controls	3
Keys and buttons	3
The display	5
Using the GMDSS VHF	6
Basic functions	6
Other functions	9
Configuring the GMDSS VHF	11
Entering and using configuration mode	11
Configuration settings	12

Chapter 3 Batteries

Battery types	15
The primary battery	15
The secondary battery	16
Battery level indication	16
Removing and inserting the battery pack	16
The battery charger	17
Installing the charger	18
Recharging the secondary battery	18

Chapter 4 Equipment and accessories

External equipment	21
Impact on radio operation	21
Accessories	22
List of accessories	22
Attaching and removing the belt clip	23
Attaching the lanyard	23

Chapter 5 Troubleshooting

Displaying errors	25
-------------------------	----

App. A Technical specifications

Technical data R5 GMDSS VHF	27
General	27
Transmitter	28
Receiver	28
Battery life guidelines	29
Dimensional drawing, transceiver	30
Dimensional drawing, chargers	31

App. B Attention

Gore-Tex Membrane	33
--------------------------------	----

Introduction

Your GMDSS VHF

Your portable VHF transceiver, is approved to fulfil the GMDSS requirements for portable VHF radios for Safety at Sea and is waterproof to the IP67 standard.

As part of the required safety equipment, the R5 is to be used in an emergency situation. However the best way to guarantee functionality in an emergency situation, is to use the radio in daily communication on board.

The unique battery concept makes the radio suited for both daily use and emergency situations. The primary emergency battery is to be stored for emergency situations and a secondary rechargeable battery can be used for daily communication in your new portable VHF transceiver.

The radio is designed with a unique man machine interface, an excellent grip even with gloves, and large tactile buttons.

The display has red adjustable backlight which makes the display visible even at night.

The radio is equipped with a lanyard and a belt clip.



Performance

For best performance of the transceiver keep the following in mind:

- Keep clear of metal environment.
- Hold the transceiver vertically and 10 cm from lips and push the PTT when transmitting.
- In receive mode carry the transceiver vertically with belt clips.
- To preserve battery power, adjust squelch to close the loudspeaker when there is no signal.

If you are in a lifeboat keep the antenna as high as possible.

Channels

This radio operates with the following channels according to the Radio Regulations Appendix 18.

Note

Channel designators xxA corresponds to 10xx defined in the Radio Regulations Appendix 18.

6	12	17	67	73	78A
8	13	19A	68	74	79A
9	14	20A	69	75 LJ	87
10	15	27A	71	76 LJ	88
11	16	28A	72	77	

LJ Tx power is limited to 1 W.

Operation

Controls





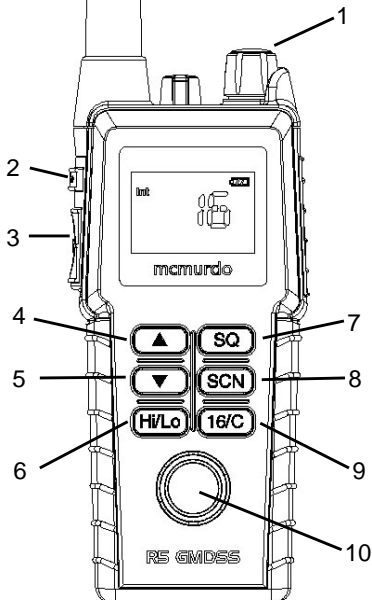

Keys and buttons

1. On/off/volume
2. Light/Lock
3. Push To Talk (PTT)
4. Up key
5. Down key
6. Hi/Lo output power
7. Squelch
8. Scan
9. Priority channel (16)/
Call channel
10. Loudspeaker/microphone



Key presses

Pressing and holding certain keys gives access to additional functions, shown in the table below.

Key	Short press (1 beep)	Long press (2 beeps)	Extra long press (3 beeps)
 	Show next available item in the list (up or down). Default: Channel selection	Run through available items, or select tagged channels A (▼) or B (▲).	Run through available items if an A or B channel is tagged
	Activate Squelch control (Adjust with up/down arrows).	Monitor function. Open Squelch completely.	
	1 press: Activate/terminate Dual/Triple watch. 2 presses: Activate memory scan.	Add/Delete channel from memory scan.	
	Toggle between high and low transmitter power.		
	Select channel 16.	Select programmed Call channel.	Program Call channel.

The display

The display holds various fields of information, explained below.

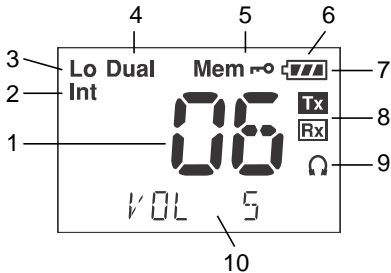

1. Current working channel.
2. Current channel mode.
3. “Lo”: Reduced transmitter power.
Full transmitter power is not shown in display.
4. Dual watch activated.
5. Current working channel is marked for scanning.
6. Keypad is locked.
7. Battery level indicator.
8. Transmitting (Tx) /Receiving (Rx).
9. Accessory is connected.
10. Service line for various purposes. In this example the volume level.

Using the GMDSS VHF

Basic functions

Note Before using the radio, mount the antenna at the top of the radio. The antenna is delivered with the radio.

Switching the radio on and off

- **To switch the radio on**, turn the knob at the top of the radio **clockwise**.
The display lights up showing the last used channel and the battery level.
- **To switch the radio off**, Turn the knob back **counter-clockwise** until it clicks.



Selecting the working channel

- To select **channel 16** (Distress or Safety), press the **16/C** key.
- To select the **Call channel**, use a long press on **16/C**.
- To select among **all available channels**, press **▲** or **▼** on the keypad. For fast selection, press and hold **▲** or **▼**.

The display shows the currently selected channel.

Note Long press on **▲** or **▼** can also be used to select preferred channels. For information on how to program preferred channels, see *Configuring the GMDSS VHF* on page 11.

Activating a call

To **activate a call** to the selected channel, press and hold the **PTT** button on the side of the radio.

The radio transmits as long as the PTT button is pressed. A small **Tx** sign next to the channel number indicates when the radio is in transmit mode.



Adjusting the volume

- To **increase** the volume, turn the on/off knob at the top of the radio **clockwise**.
- To **decrease** the volume, turn the knob **counter-clockwise**.

The display shows the level of the volume, e.g. “VOL 5”, while it is adjusted.

Using Squelch control

- To **activate** Squelch control, press the **SQ** key.
- To **set** the Squelch level, press ▲ (closing) or ▼ (opening). The display shows the Squelch level while it is adjusted, e.g. “SQ 5”.

Adjusting the display backlight

- To **turn on** the backlight, press the **Light/Lock** button on the side of the radio.
- To **adjust** the backlight level, press ▲ or ▼ within 3 seconds after turning on the light. The display shows the level while it is adjusted, e.g. “DIM MED”.



Using Dual watch

To activate Dual watch, press the **SCN** key.

The display shows “Dual” at the top and “16” at the bottom right.

The radio toggles between the selected channel and channel 16.

- **To terminate** Dual watch, press **SCN** again.

Scanning channels

- **To activate** scanning memory, press 2 times **SCN** within 2 seconds.

During scanning, the display shows “SC” in the channel field. The radio toggles between channel 16 and each of the channels marked for scanning.

- **To terminate** scanning, press **SCN** once.

Changing the transmitter power

To change the transmitter power, press the **Hi/Lo** key. The display shows “LO” when power is set to low. Otherwise maximum power is used.

Locking the keypad

- **To lock** the keypad, press and hold the **Light/Lock** button. The display shows a key symbol when the keypad is locked.
- **To unlock** the keypad, press and hold the **Light/Lock** button again.

Other functions

Programming the Call channel

To program the Call channel, do as follows:

1. Press and hold **16/C** until the current Call channel number is flashing.
2. Select the channel with **▲** or **▼**.
3. Press **16/C** to confirm.

Programming the scanning memory

To add a channel to the scanning memory, select the channel and then press and hold the **SCN** key until the display shows **MEM** at the top.

To remove a channel from the scanning memory, select the channel and then press and hold the **SCN** key until the **MEM** sign disappears from the display.

Alive beep

To enable “ALIVE” function do as follows:

1. Select the channel where ALIVE function is desired to be transmitted.
2. Press and hold the **Hi/Lo** until you see “ALIVE ON” on the radio display. It takes approx. a second.
3. Now “ALIVE” is transmitted by a “beep” on the working channel, with approx. 4-second intervals.

To deactivate “ALIVE” function do as follows:

- Press and hold the **Hi/Lo** pressed until “ALIVE ON” no longer appears on the radio display. It takes approx. a second.

“ALIVE” function is also deactivated when

- The channel is changed.
- The radio is turned OFF and ON again.
- Watch or scanning is enabled.
- Squelch is open.

Refer to *ALIVE* on page 13

Configuring the GMDSS VHF

Entering and using configuration mode

Note | The radio is not operational in configuration mode.

- **To enter** configuration mode, press and hold the **Light/Lock** button while turning on the radio.
The bottom line of the display shows the current menu item/setting.
- **To exit** configuration mode, turn off the radio or press any key except ▲, ▼ and the Light/Lock button.
Using the PTT button or leaving the radio inactive for 10 seconds also causes the radio to exit configuration mode.
- **To change** a setting, press ▲ or ▼.
- **To confirm the current setting** and go to the next menu item, press the **Light/Lock** button.

Configuration settings

Configuration mode is used to program preferred channels and volume of key beep and battery alarm.

The following settings are available in configuration mode.

BEEP	MAX	Status click/beep sound on key press, long press (settings/programming saved) and battery alarm. Maximum level.
	MIN	Status click/beep sound on key press, long press (settings/programming saved) and battery alarm. Minimum level.
	OFF	All beeps off.
PREFA	OFF	Remove tag "A" for current working channel.
	ON	Tag current working channel with "A". If another channel was previously tagged "A", this is overruled. <ul style="list-style-type: none"> The working channel can now be selected with a long press on ▼.
PREFB	OFF	Remove tag "B" for current working channel.
	ON	Tag current working channel with "B". If another channel was previously tagged "B", this is overruled. <ul style="list-style-type: none"> The working channel can now be selected with a long press on ▲.
VER	X.XX.XX	Software version. Read-only.

ALIVE	OFF	Factory default state.
	ON	Press ▲ to set “ALIVE” on.
ADD NAME	A-Z, 0-9	Makes it possible to name the channels. The name must contain a maximum of 9 characters, use only capital letters, digits and spaces. Press Light/Lock to confirm programming. Note: The name appears in the service line on the display.

Batteries

Battery types

- The yellow primary battery pack contains a non-rechargeable Lithium battery. This battery pack is only to be used in case of emergency.
- The black secondary battery pack contains a rechargeable battery. This battery pack is for daily use.

The primary battery

Important

The yellow primary battery pack is only for emergency use, and is **not** rechargeable.

Before using the primary battery, remove the seal on the battery pack.

Then do as follows:

1. Attach the battery pack to the radio as shown.
2. Lock the battery with the safety lock at the bottom.

The primary battery is capable of providing sufficient power for 8 hours of operation defined as 10% Tx, 10% Rx and 80% standby.

When the primary pack is not in use it must always be placed in the dedicated rear position in the charger cradle, see *The battery charger* on page 17.



The secondary battery

Battery level indication

The black secondary battery pack is for daily use of the radio. When the battery level is low, you should recharge the battery.

The radio display shows the battery status. When the battery symbol is empty and flashing, the battery should be recharged as soon as possible.

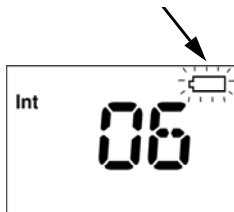

Removing and inserting the battery pack

To remove the battery pack, do as follows:

1. Open the safety lock as shown.
2. Remove the battery.

To insert the battery pack, attach the battery and close the safety lock as shown on the previous page.



The battery charger

The chargers has two compartments.

Single Charger Kit

- A rear compartment only for storing a spare battery. It does not have a charger function.
- A front compartment for recharging the battery alone or while attached to the radio.

Single Charger Accessory Option
Secondary battery (black, rechargeable)
Single Charger Base
AC/DC converter, length 150cm (100-240V~/12V DC out)
12-24V DC Connection cable, length 150cm



Dual Charger Kit

- It is possible to charge a battery in rear compartment simultaneously with the radio/battery in front.

Installing the charger

Mounting the charger

There are several options for mounting one or more chargers on a table or a wall.

For information on dimensions and screw positions, refer to *Dimensional drawing, chargers* on page 31.

When mounting the charger, make sure it is placed in a dry place and away from direct sunlight. The charger is not waterproof.

Connecting to power

The charger can be supplied with DC or AC.

DC: Connect the 12-24VDC Connection Cable between the DC supply and the connector on the underside of the charger.

AC: Connect the AC/DC adapter to the connector on the underside of the charger. Then connect the AC/DC adapter to the AC outlet.

Recharging the secondary battery

Important | Do not attempt to recharge the yellow primary battery!

To recharge the secondary battery, place the radio with battery or the battery alone in the front position of the charger cradle.

If the radio cannot turn on due to completely discharged battery, then **turn off** the radio and place it in the charger or charge the battery alone.

The light indicators on the charger cradle show the status as follows:

- Green light: Power is connected to the charger.
- Slow red flash: Charging in progress.

- Quick red flash (twice per second): Charging error, e.g. battery defect or temperature out of range.
- Steady red light: Charging completed. Trickle charge mode.

Charging time with empty battery: VHF off approx. 4 hours, VHF on: approx. 5 hours.

The battery indicator on the radio display indicates if the radio is placed in the charger while radio and charger are both powered.



Equipment and accessories

External equipment

The R5 VHF radio accessory connector can support remote handset or headset connection. Contact the supplier of the accessory device for detailed connection information.

When external equipment is connected to the radio, the right side of the display will show a headset.

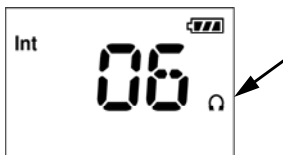

Impact on radio operation

The external equipment can have a built-in PTT button, speaker and microphone. Thus a connection has per default the following impact on the radio operation:

- If a speaker or earpiece is built into the detected external equipment, the sound device of the external equipment is used, and the internal radio speaker is disabled.
- The external accessory microphone is selected as audio input device, when the external PTT button is pressed. The transceiver microphone is used as audio input device when the transceiver PTT button is pressed.
- This behaviour can be changed in the service tool.

Accessories

List of accessories

The following accessories are delivered with your radio:

Accessory
Primary battery non rechargeable, B3502
Belt clip
Antenna
Lanyard
User Manual (this manual)

Batteries, charger, AC/DC Converter and **12VDC Connection** are described in *Batteries* on page 15.

To mount the **antenna**, simply screw it into the threaded bush at the top of the radio.

Use of **lanyard** is only for hand held operation. Put it around the wrist to prevent dropping the radio.

Accessories you may buy

Accessory
Dual Position Charger Kit

Attaching and removing the belt clip

To attach the belt clip, slide the belt clip upwards into the rails at the back of the radio until it locks.

To remove the belt clip, press the projection at the top of the belt clip to release the lock and slide the belt clip downwards out of the rails.

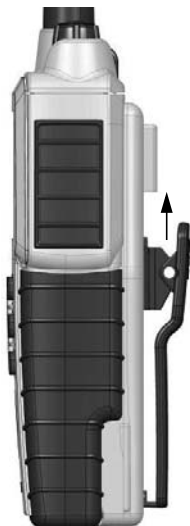
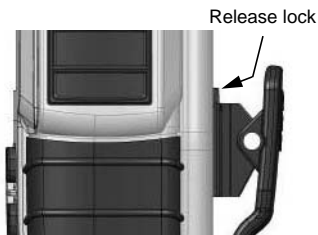

Attaching the lanyard

Do as follows:

1. Take the lanyard through the eye at the top of the radio.
2. Put one end of the lanyard through the loop at the other end of the lanyard and pull to tighten.



Troubleshooting

Displaying errors

Some errors result in an error message in the display. These error messages are listed below.

Display text	Problem	Type	Actions
Err EMPTY BAT	The battery voltage is below a critical level, where further operation would damage the battery.	Severe. Radio is non-functional.	Change/recharge the battery.
Err HW ERR	Hardware error.	Severe. Radio is non-functional.	Service required.
ILLEGAL	Context fails operation. This text will appear on the following occasions: <ul style="list-style-type: none"> • Multiple watch is selected on channel 16, or in channel regions where it is not allowed. • High power is selected on a channel where it is prohibited. • Transmission on blocked channels 	Fail operation	Consider operation in a different context.

Technical specifications

Technical data R5 GMDSS VHF

General

Item	Specification
RX frequency range	155.000 - 163.425 MHz
TX frequency range	155.000 - 161.450 MHz
Modulation	16K0G3E
Power supply	7.2 VDC Li battery
Current drain at 2 W TX	1.4 A
Current drain at 1 W TX	0.8 A
Current drain RX max audio	0.25 A
Antenna port	50 ohm
Battery (option)	Lithium-Ion, 1800 mAh rechargeable
Operating temperature	-20°C to +55° C
Water ingress protection	IP67
Frequency stability	Better than ± 0.7 kHz
Weight with emergency battery	340g

Transmitter

Item	Specification
RF output power	2 W /1 W
RF output power, Canada	2.5 W \pm 1 dB / 0.75 W \pm 1 dB
Max deviation	\pm 5 kHz
Spurious emission	< 0.25 μ W
Adjacent channel power	> 70 dB

Receiver

Item	Specification
Sensitivity (20 dB SINAD)	-117 dBm typical
Intermodulation	Better than 70 dB
Spurious response	> 70 dB
Adjacent channel selectivity	> 70 dB
Audio output, internal	0.25 W at 10% dist.
Audio output, external	0.25 W/8 ohm

Battery life guidelines

Note

New batteries should be placed in the charger for minimum 12 hours first time.

During daily use, always keep the battery fully charged and away from hot areas.

Keep the battery terminals dry and clean.

Never discharge beyond the specifications of the battery.

Operation/Standby time depends on usage. Generally, the more the radio is transmitting, the faster it will drain the battery. Also, the “Hi” power setting will drain the battery faster than the “Lo” setting.

Approximate figures are:

- A battery can be stored for 4 to 6 month at 25°C if charged to 25%.
- The battery will normally last for 5 to 9 hours of use on a fully charged battery.

Dimensional drawing, transceiver

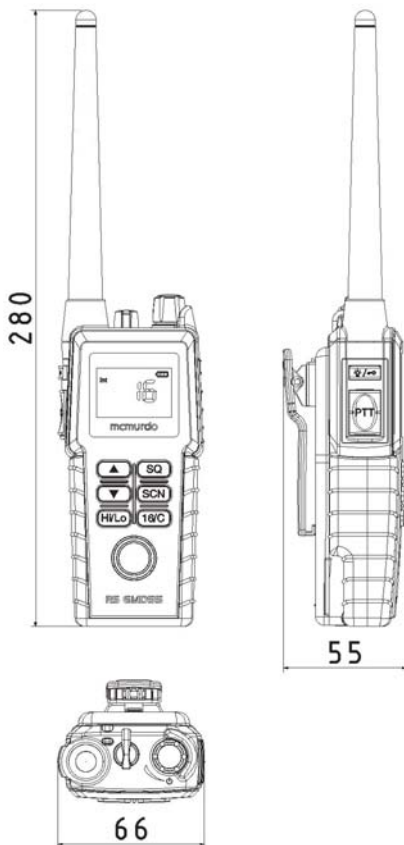

Dimensional drawing, chargers

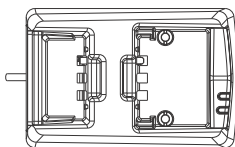
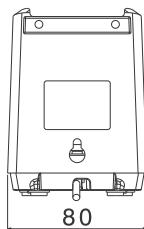
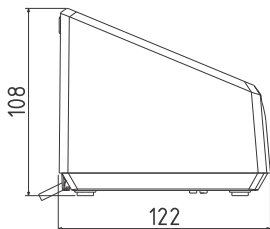

Mounting Possibilities

Desktop mounting, top view

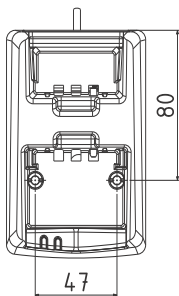

Wall mounting, rear view

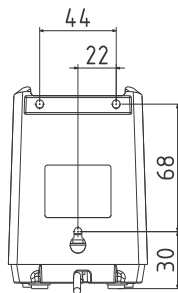

Attention

Gore-Tex Membrane

To keep the VHF watertight, it is very important that the Gore-Tex membrane under no circumstances must be damaged/covered or removed.

That is, do not remove the Gore-Tex membrane or place any labels in the area.



Orolia Ltd

Silver Point
Airport Service Road
Portsmouth PO3 5PB
United Kingdom

Phone: +44 (0)23 9262 3900

Fax: +44 (0)23 9262 3998

Email: customer.service@mcmurdogroup.com

Website: www.mcmurdogroup.com

20-150 Issue 5

An Orolia Group Business